

ホイール取り付け面

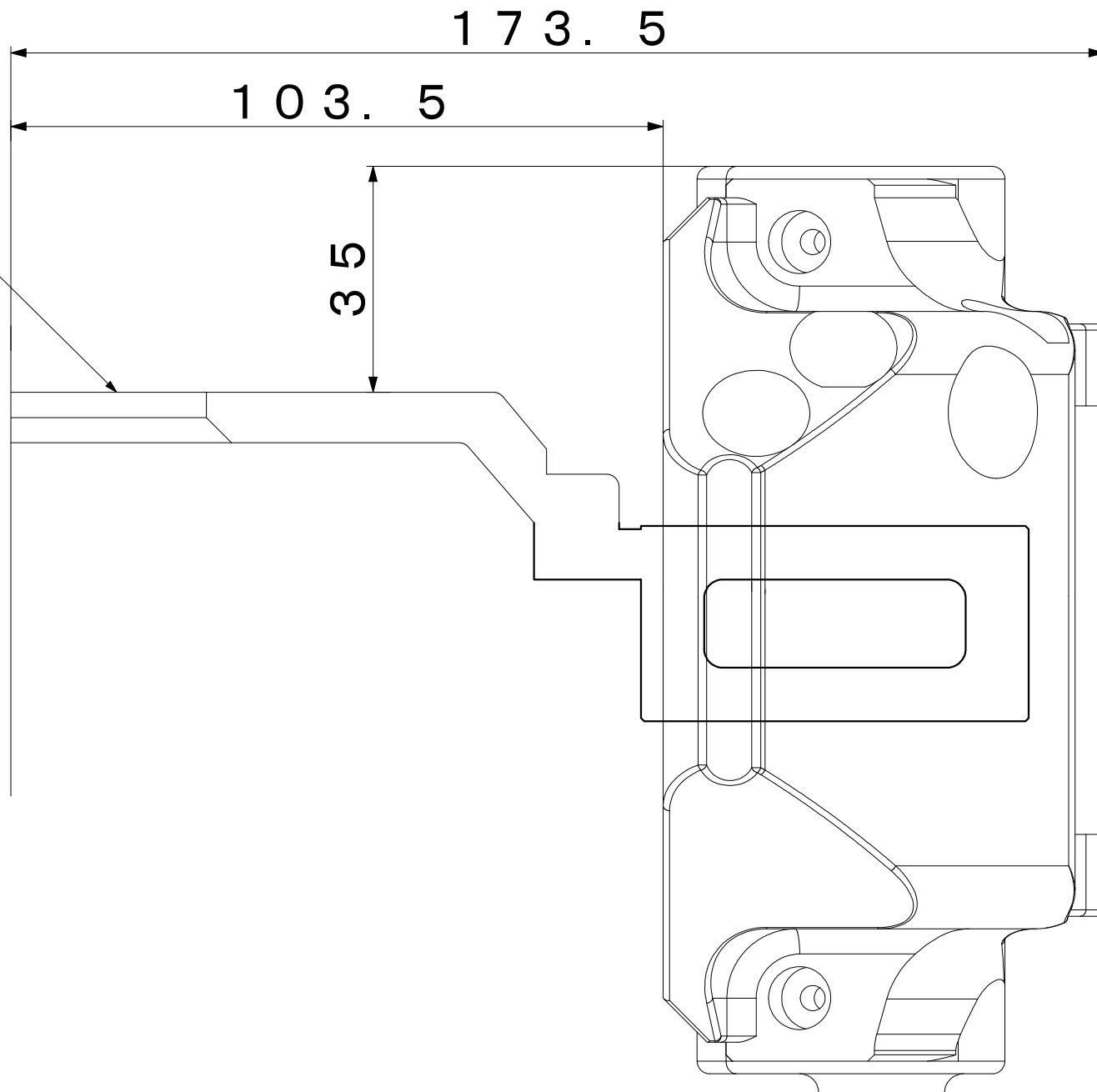

FS4M-T126SP